 <p>Republic of the Philippines METROPOLITAN NAGA WATER DISTRICT 40 J. Miranda Avenue, Naga City</p>	PREPARED BY:  SAMUEL A. AMORES OIC-Div. Mgr., PDC	CHECKED BY:  SONJUNO O. MILLARES OIC - Dept. Mgr., EED	RECOMMENDING APPROVAL:  ROQUE S. FRANCISCO AGM, O & TS	APPROVED:  FLORENCIO T. MONGOSO, JR. General Manager A	PROJECT TITLE/LOCATION: PROPOSED TRANSMISSION LINE PROJECT Pacol IV PS to Corner Happy Homes Highland to Deca Homes Vistanza Road, Barangay Pacol, Naga City 200mm Ø = 2,497 LM, 100mm Ø = 12 LM, 50mm Ø = 295 LM	SHEET CONTENTS : Vicinity Map _____ _____ _____ CADD BY: juliet Date Activated:	SHEET NO.: 1 9 03 - 2024

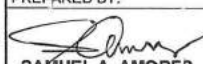

LEGEND :

- PROP. 200mm Ø uPVC PIPE, CL 150**
w/ Machine installed plastic ring
Homogenously Bonded w/RR
- PROP. 100mm Ø uPVC PIPE, CL 150**
w/ Machine installed plastic ring
Homogenously Bonded w/RR
- PROP. 50mm Ø uPVC PIPE, CL 150**
w/ Machine installed plastic ring
Homogenously Bonded w/RR
- PROP. 150mm Ø FIRE HYDRANT**
- EXISTING 100mm Ø uPVC PIPE, CL 150**
w/ Machine installed plastic ring
Homogenously Bonded w/RR

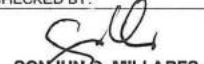
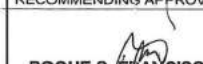
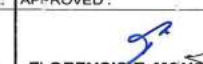
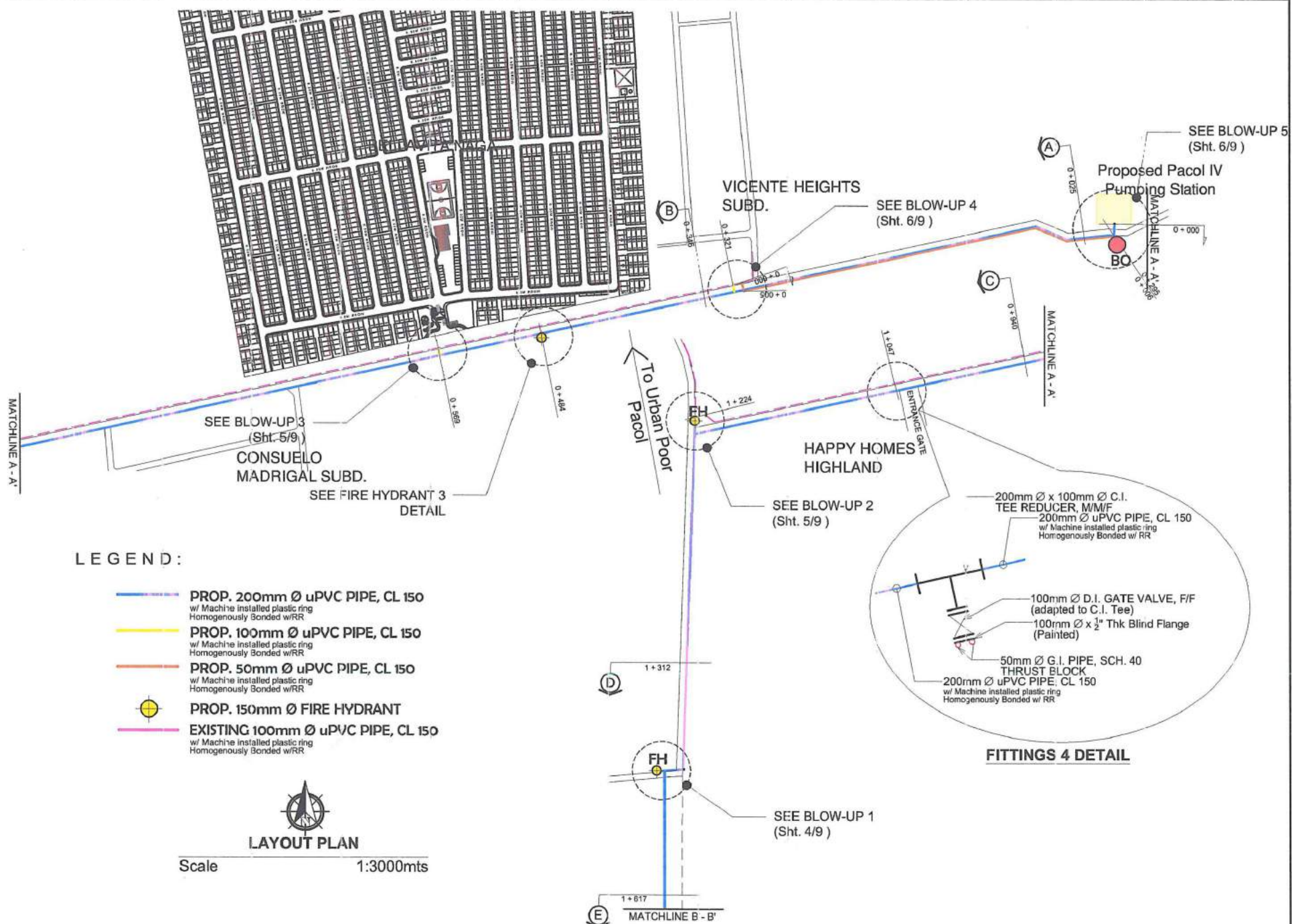
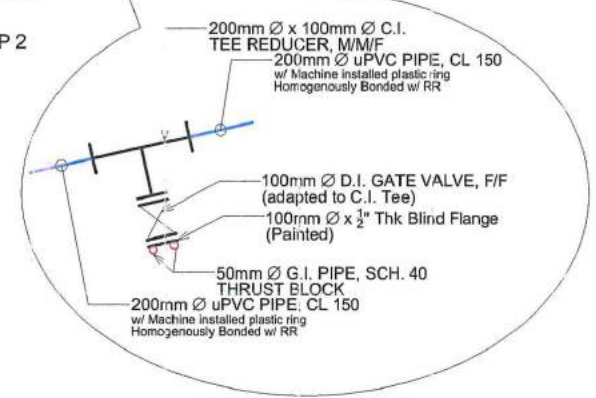

Scale 1:3000mts

 Republic of the Philippines METROPOLITAN NAGA WATER DISTRICT 40 J. Miranda Avenue, Naga City	PREPARED BY: SAMUEL A. AMORES CIC-Div. Mgr., PRSD	CHECKED BY: SONJUN O. MILLARES CIC-Div. Mgr., EED	RECOMMENDING APPROVAL: ROQUE S. FRANCISCO ACM, O & TS	APPROVED: FLORENCIO T. MONGOSO, JR. General Manager A	PROJECT TITLE/LOCATION: PROPOSED TRANSMISSION LINE PROJECT Pacol IV PS to Corner Happy Homes Highland to Decca Homes Vistanza Road, Barangay Pacol, Naga City 200mm Ø = 2,497 LM, 100mm Ø = 12 LM, 50mm Ø = 295 LM	SHEET CONTENTS: Layout Plan	SHEET NO.:
							2
					CADD BY: Juliet	Date Activated:	03 - 2024

MATCHLINE B - B'

LEGEND:

-  **PROP. 200mm Ø uPVC PIPE, CL 150**
w/ Machine installed plastic ring
Homogenously Bonded w/RR
-  **EXISTING 200mm Ø uPVC PIPE, CL 150**
w/ Machine installed plastic ring
Homogenously Bonded w/RR

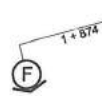

LAYOUT PLAN

Scale 1:3000mts

To Deca Homes
Vistansa

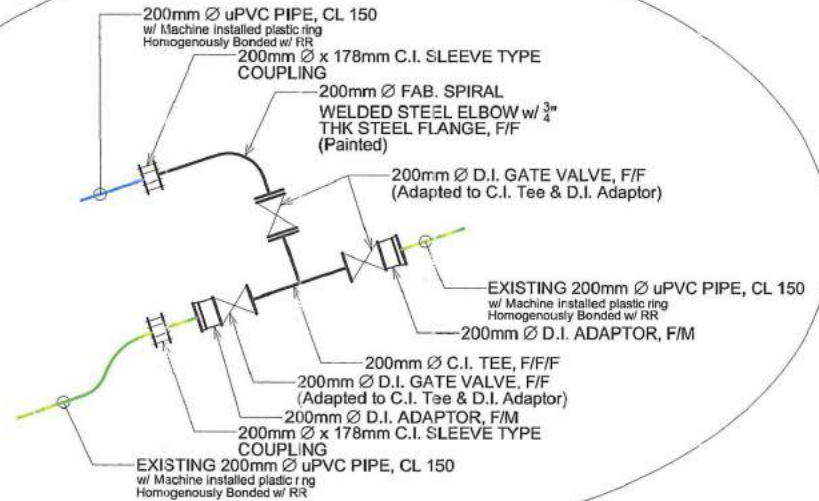

**INTERCONNECTION I TO EXISTING
WATERLINE DETAIL**

N T S

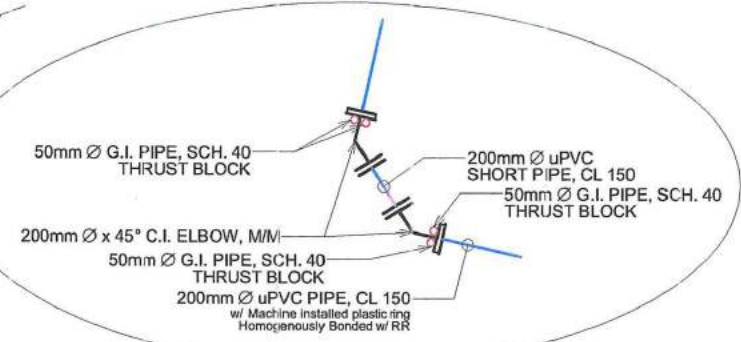

FITTINGS 1 DETAIL

Republic of the Philippines
**METROPOLITAN NAGA
WATER DISTRICT**
40 J. Miranda Avenue, Naga City

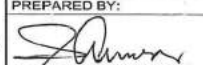
PREPARED BY:

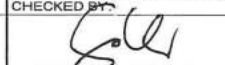
SAMUEL A. AMORES
CIC-Div. Mgr., POCB

CHECKED BY:

SONJUNO O. MILLARES
OIC - Dept. Mgr., EED

RECOMMENDING APPROVAL:

ROQUE S. FRANCISCO
ACM, O & TS

APPROVED:

FLORENCIO T. MONGOSO, JR.
General Manager A

PROJECT TITLE/LOCATION:
PROPOSED TRANSMISSION LINE PROJECT
Pacol IV PS to Corner Happy Homes Highland to Deca Homes
Vistanza Road, Barangay Pacol, Naga City
200mm Ø = 2,497 LM, 100mm Ø = 12 LM, 50mm Ø = 295 LM

SHEET CONTENTS:	SHEET NO.:
Layout Plan	3
	9
CADD BY: Juliet	Date Activated: 03 - 2024

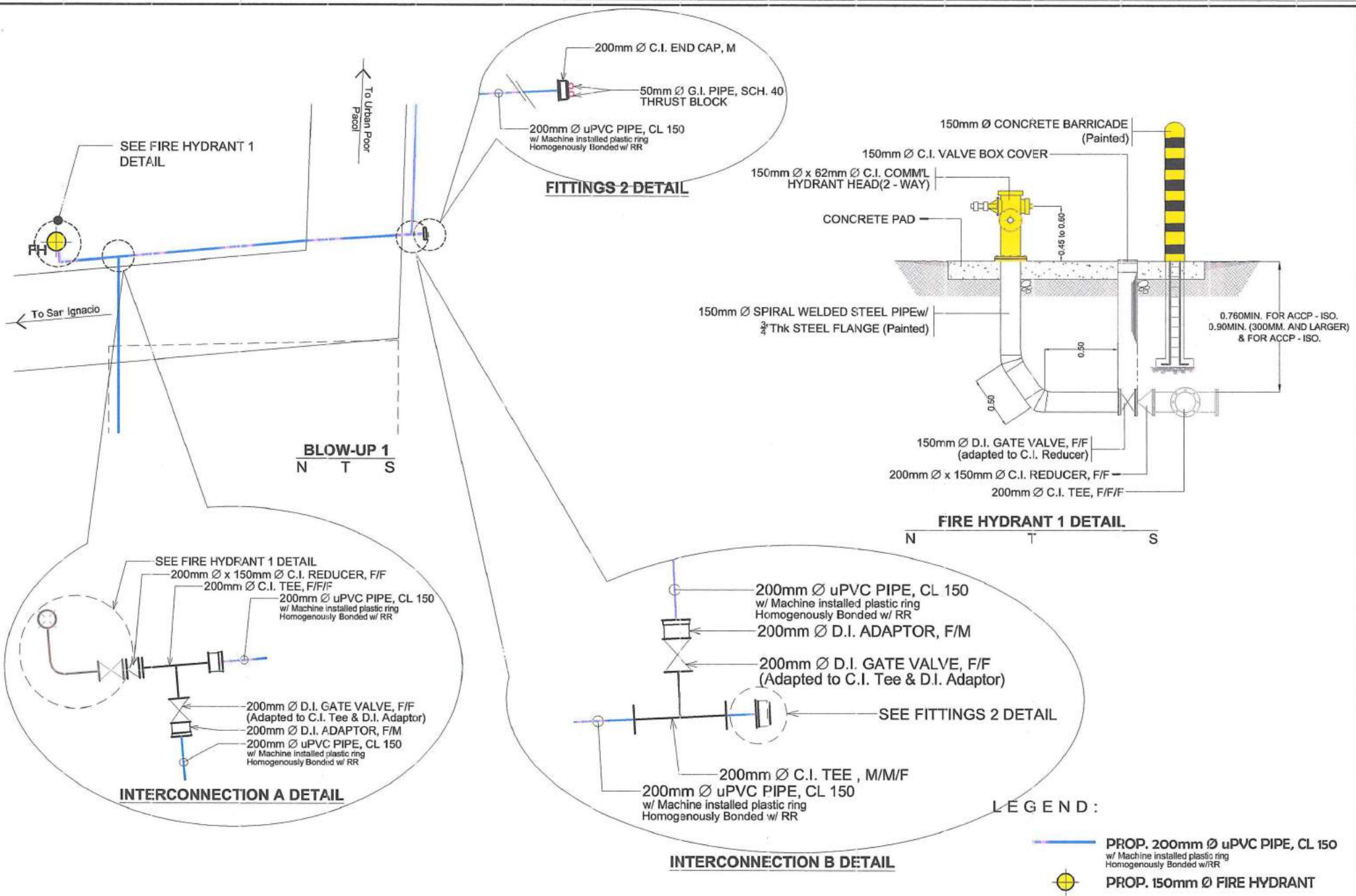

<p>Republic of the Philippines METROPOLITAN NAGA WATER DISTRICT 40 J. Miranda Avenue, Naga City</p>	<p>PREPARED BY:</p> <p>SAMUEL A. AMORES CIC-Div. Mgr., EED</p>	<p>CHECKED BY:</p> <p>SONUN O. MILLARES OIC - Dept. Mgr., EED</p>	<p>RECOMMENDING APPROVAL:</p> <p>ROQUE S. FRANCISCO AGM, O & TS</p>	<p>APPROVED :</p> <p>FLORENCIO T. MONGOSO, JR. General Manager A</p>	<p>PROJECT TITLE/LOCATION:</p> <p>PROPOSED TRANSMISSION LINE PROJECT Pacol IV PS to Corner Happy Homes Highland to Deca Homes Vistanza Road, Barangay Pacol, Naga City 200mm Ø = 2,49' LM, 100mm Ø = 12 LM, 50mm Ø = 295 LM</p>	<p>SHEET CONTENTS :</p> <p>As Shown</p>	<p>SHEET NO.:</p> <p>4 9</p>
	<p>CADD BY: Juliet Date Activated: 03 - 2024</p>						

LEGEND :

-  PROP. 200mm Ø uPVC PIPE, CL 150
w/ Machine installed plastic ring
Homogenously Bonded w/RR
-  PROP. 100mm Ø uPVC PIPE, CL 150
w/ Machine installed plastic ring
Homogenously Bonded w/RR
-  PROP. 150mm Ø FIRE HYDRANT
-  EXISTING 100mm Ø uPVC PIPE, CL 150
w/ Machine installed plastic ring
Homogenously Bonded w/RR

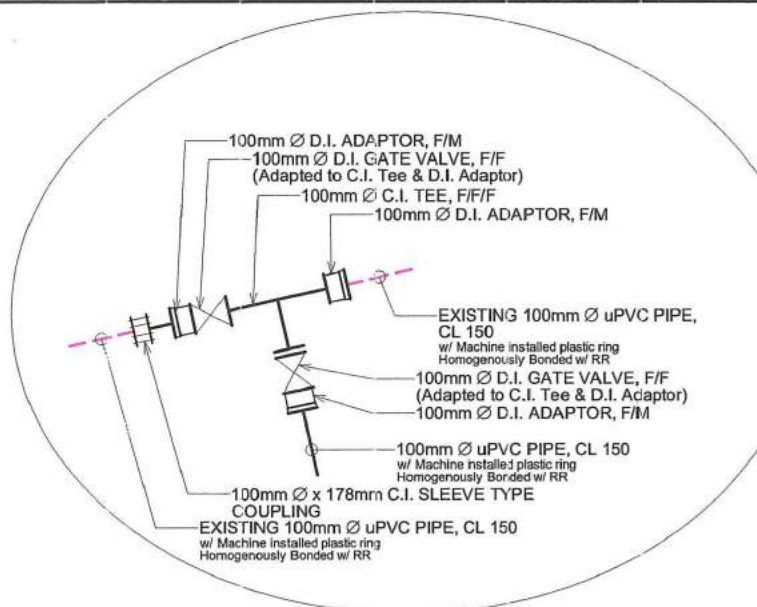

INTERCONNECTION II TO EXISTING WATERLINE DETAIL

N T S

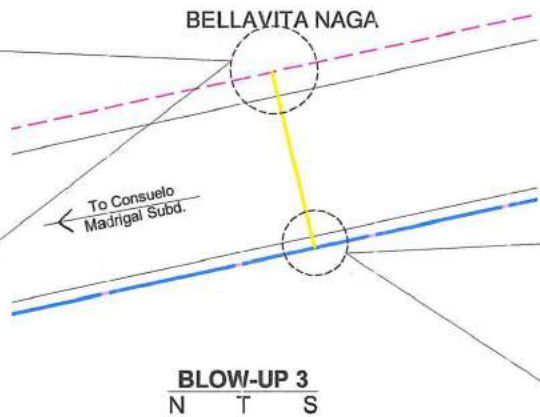

BLOW-UP 3
N T S

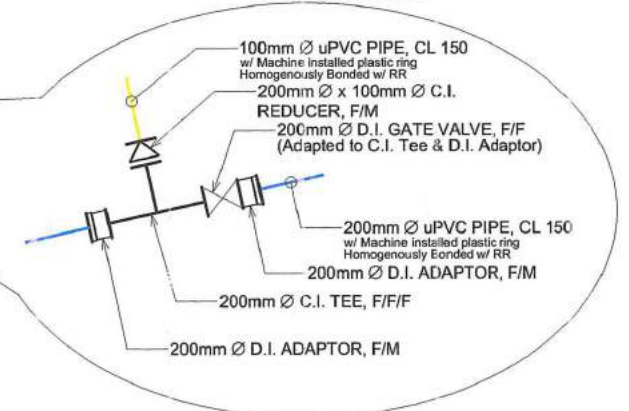

INTERCONNECTION D DETAIL

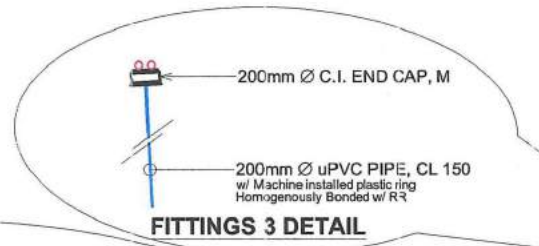

FITTINGS 3 DETAIL

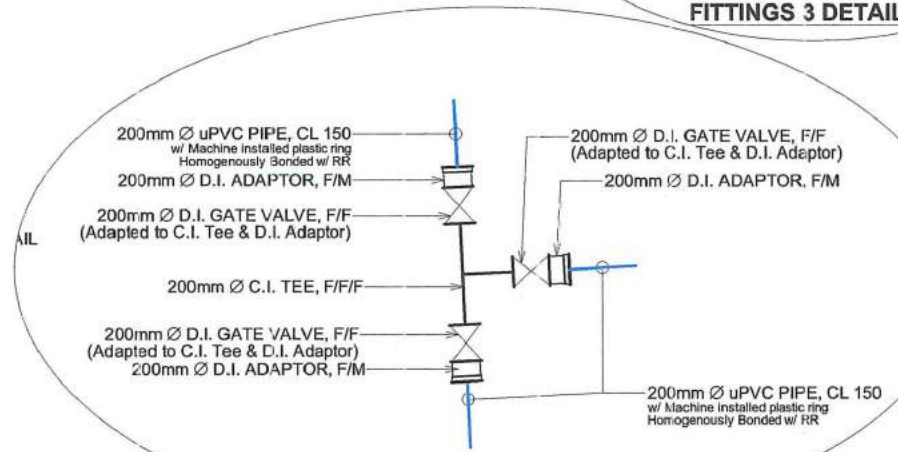

INTERCONNECTION C DETAIL

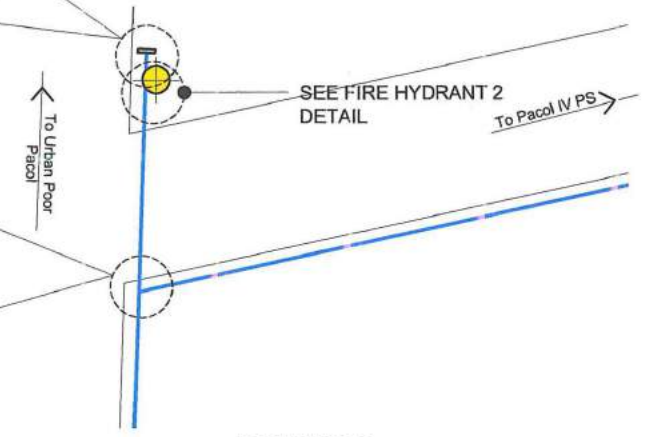

BLOW-UP 2
N T S

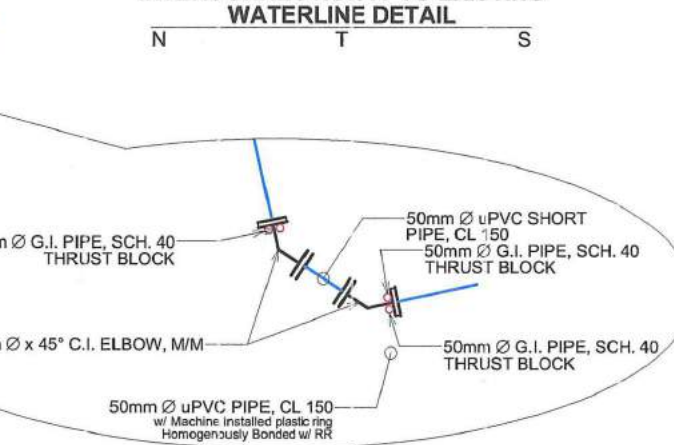
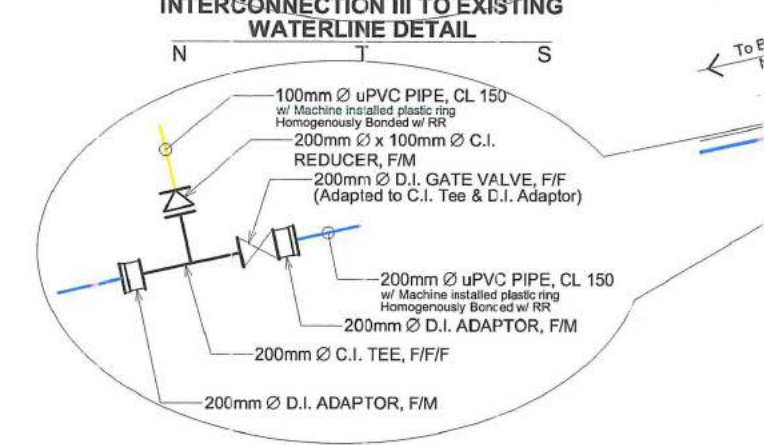
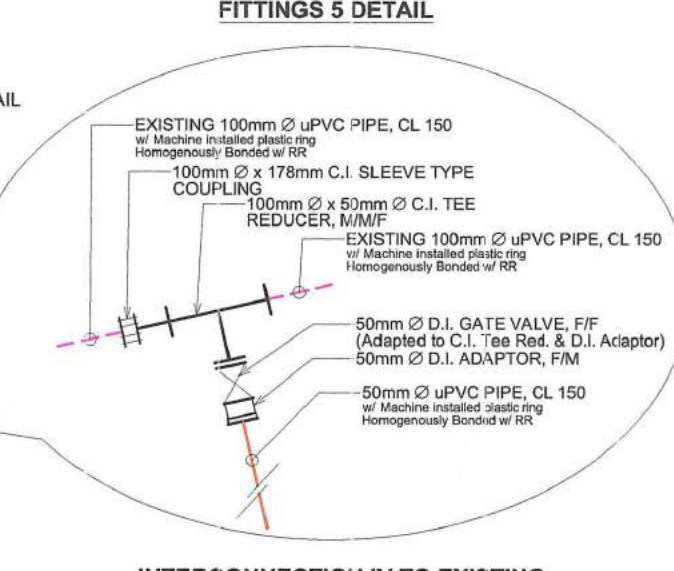
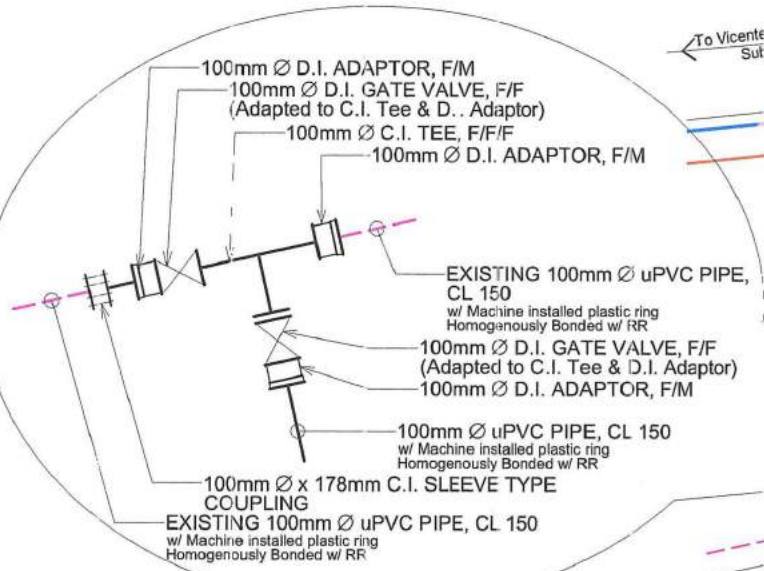
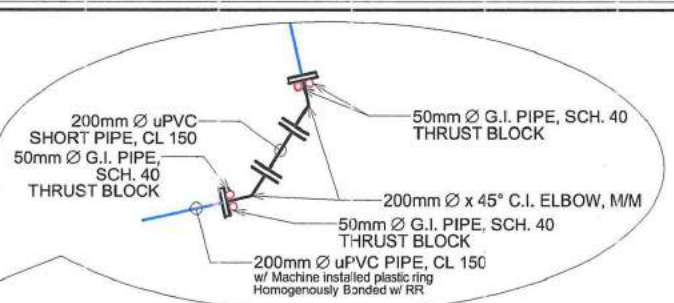
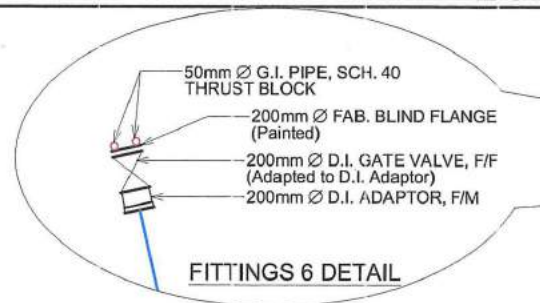
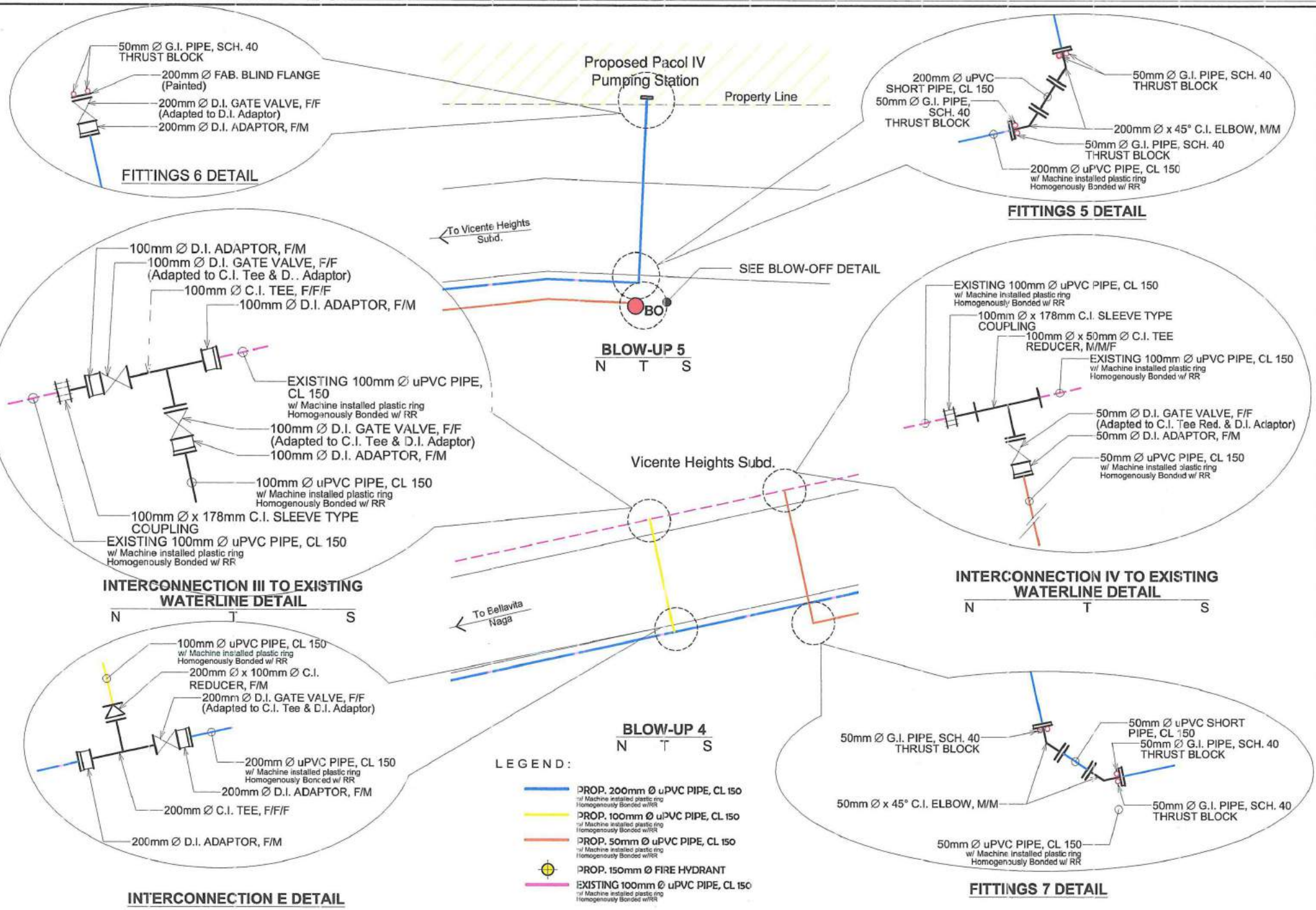

Proposed Pacol IV Pumping Station

BLOW-UP 5
N T S

BLOW-UP 4
N T S

- LEGEND:**
- PROP. 200mm Ø uPVC PIPE, CL 150 w/ Machine installed plastic ring Homogeneously Bonded w/ RR
 - PROP. 100mm Ø uPVC PIPE, CL 150 w/ Machine installed plastic ring Homogeneously Bonded w/ RR
 - PROP. 50mm Ø uPVC PIPE, CL 150 w/ Machine installed plastic ring Homogeneously Bonded w/ RR
 - PROP. 150mm Ø FIRE HYDRANT
 - EXISTING 100mm Ø uPVC PIPE, CL 150 w/ Machine installed plastic ring Homogeneously Bonded w/ RR

Republic of the Philippines
METROPOLITAN NAGA WATER DISTRICT
40 J. Miranda Avenue, Naga City

PREPARED BY:
[Signature]
SAMUEL A. AMORES
CIC-Div. Mgr., PBCD

CHECKED BY:
[Signature]
SONJUN O. MILLARES
CIC-Dept. Mgr., EED

RECOMMENDING APPROVAL:
[Signature]
ROQUE S. FRANCISCO
AGM & TS

APPROVED:
[Signature]
FLORENCIO T. MONGOSO, JR.
General Manager A

PROJECT TITLE/LOCATION:
PROPOSED TRANSMISSION LINE PROJECT
Pacol IV PS to Corner Happy Homes Highland to Deca Homes
Vistanza Road, Barangay Pacol, Naga City
200mm Ø = 2,497 LM, 100mm Ø = 12 LM, 50mm Ø = 295 LM

SHEET CONTENTS:
As Shown

SHEET NO.:
6
9
CADD BY: Juliet Date Activated: 03-2024

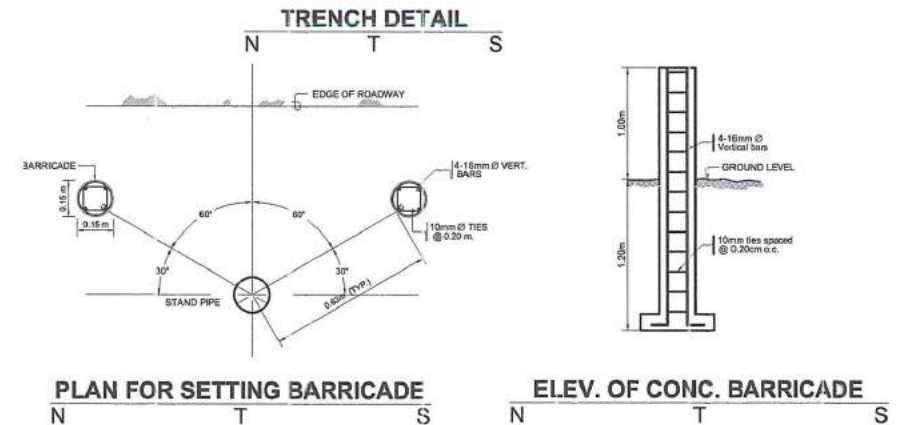
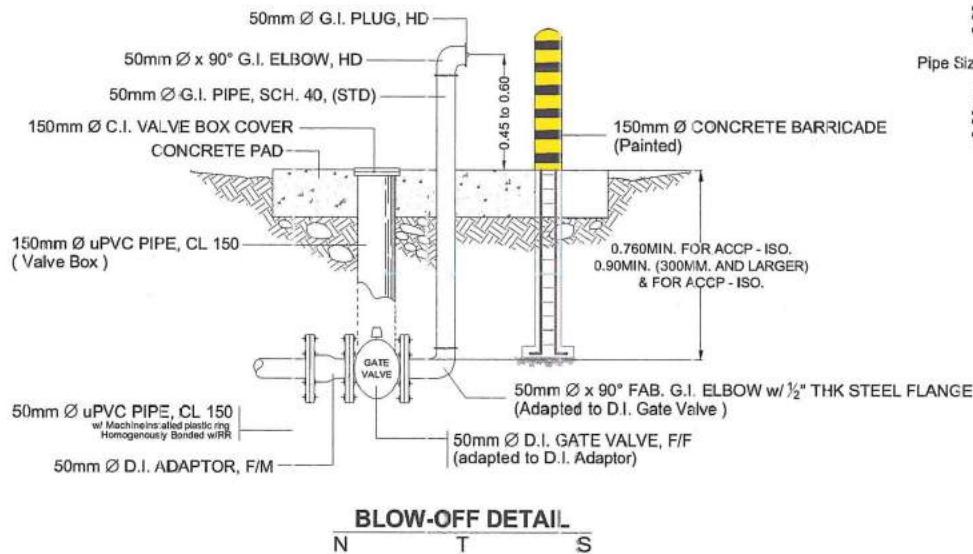
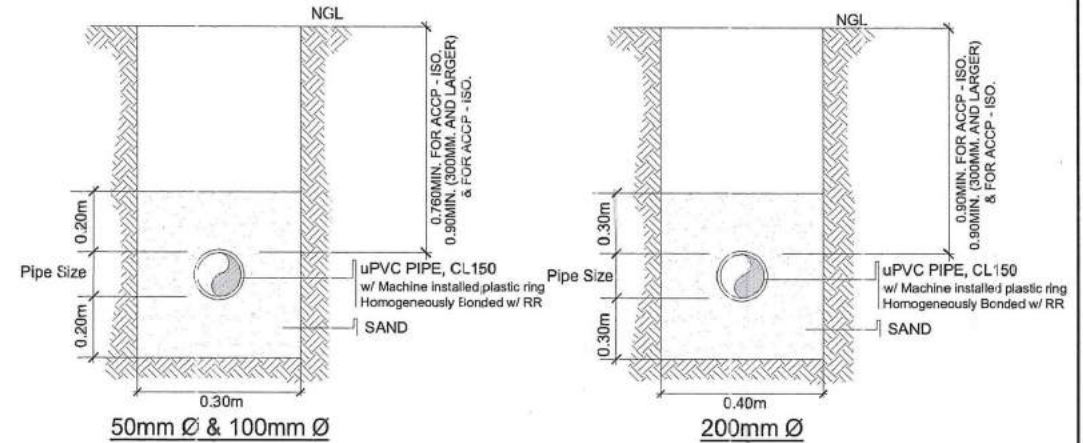
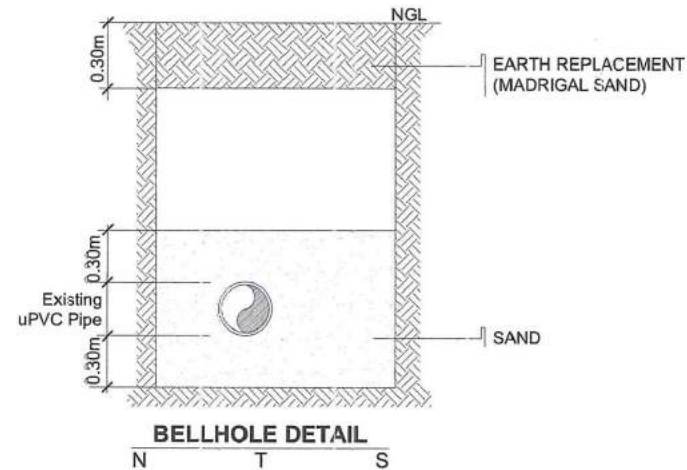
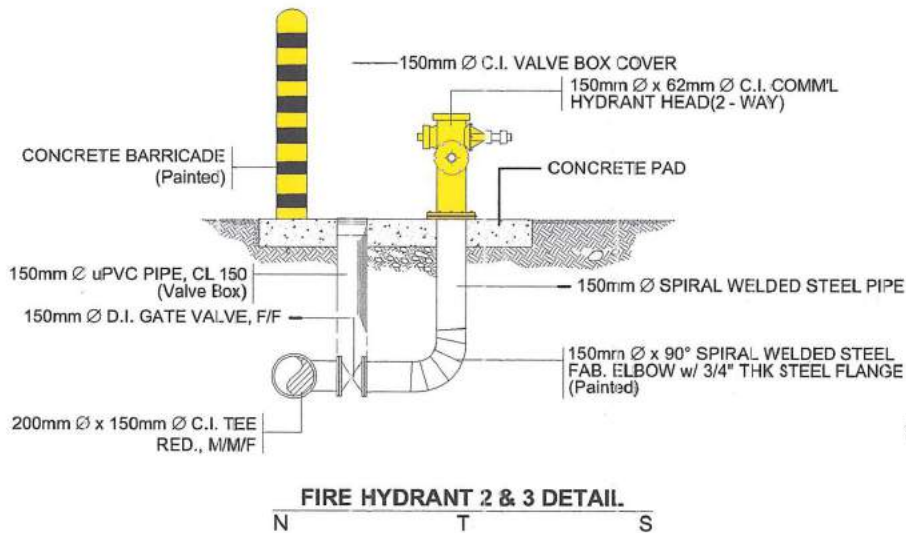

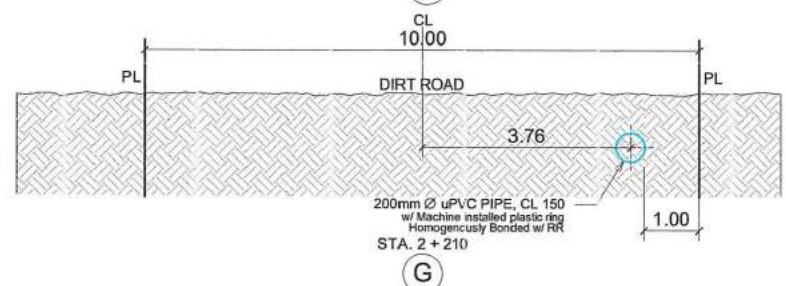
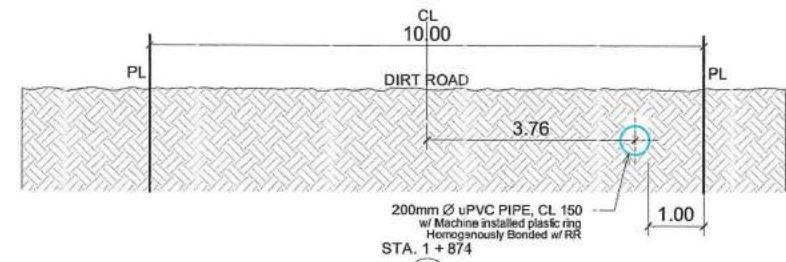
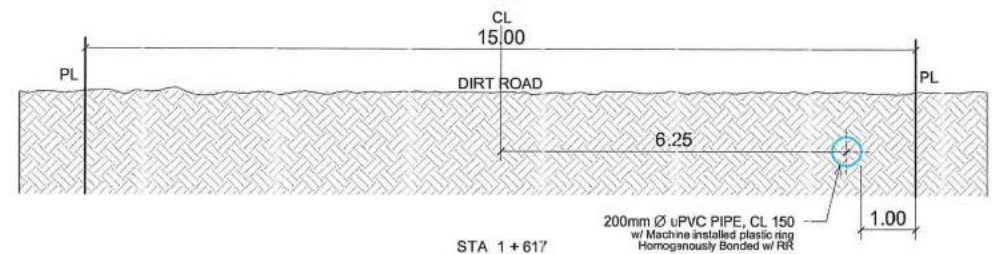
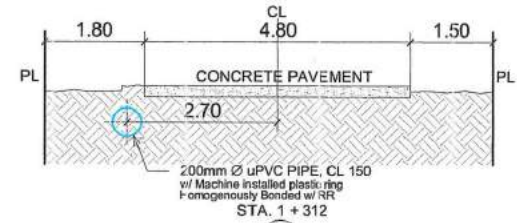
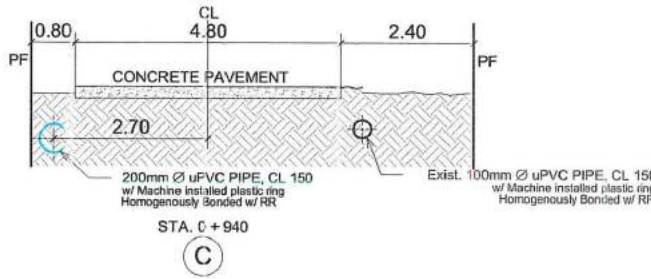
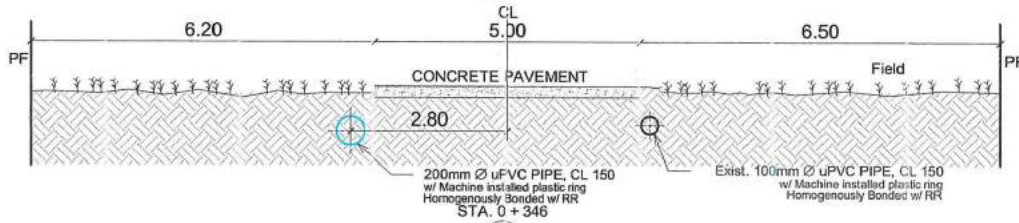
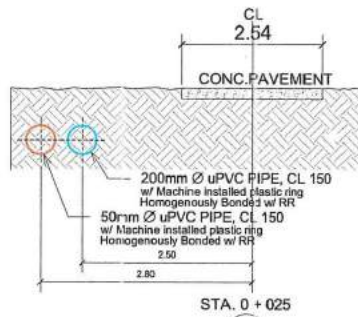

ROAD CROSS-SECTION DETAIL
N T S

<p>Republic of the Philippines METROPOLITAN NAGA WATER DISTRICT 40 J. Miranda Avenue, Naga City</p>	<p>PREPARED BY: <i>Samuel A. Amores</i> SAMUEL A. AMORES OIC - Div. Mgr., PDCD</p>	<p>CHECKED BY: <i>Son Jun O. Millares</i> SON JUN O. MILLARES OIC - Dept. Mgr., EED</p>	<p>RECOMMENDING APPROVAL: <i>Roque S. Francisco</i> ROQUE S. FRANCISCO AGM, CLTS</p>	<p>APPROVED: <i>Florencio T. Mongoso, Jr.</i> FLORENCIO T. MONGOSO, JR. General Manager A</p>	<p>PROJECT TITLE/LOCATION: PROPOSED TRANSMISSION LINE PROJECT Pacol IV PS to Corner Happy Homes Highland to Deca Homes Vistanza Road, Barangay Pacol, Naga City 200mm Ø = 2,497 LM, 100mm Ø = 12 LM, 50mm Ø = 295 LM</p>	<p>SHEET CONTENTS: Road Cross-Section Detail</p>	<p>SHEET NO.: 8 9</p>
	<p>CADD BY: juliet Date Activated: 03 - 2024</p>						

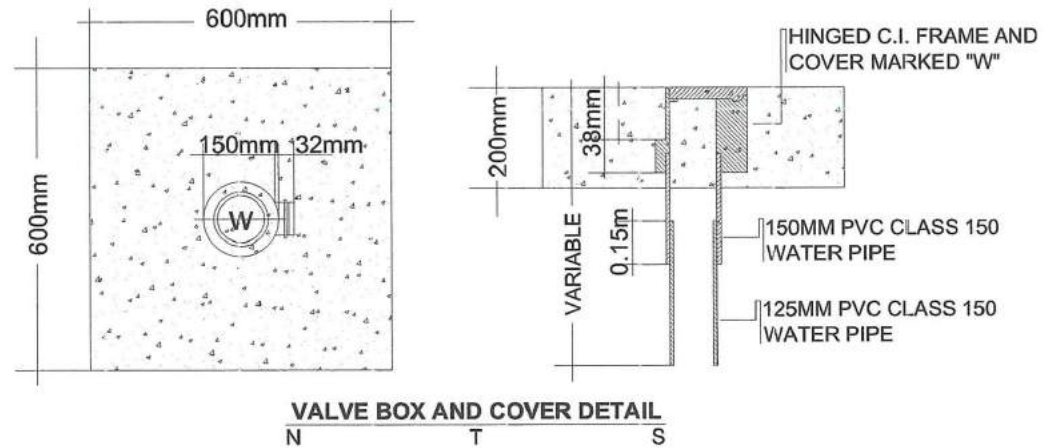
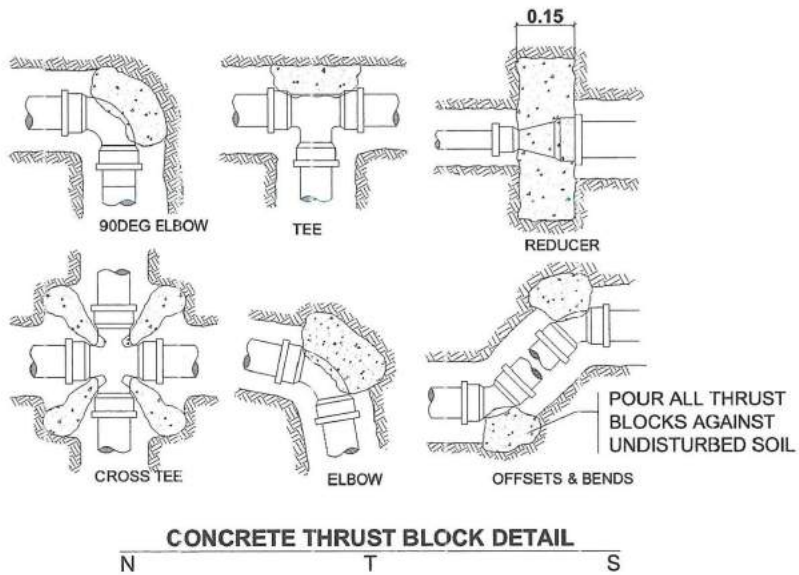
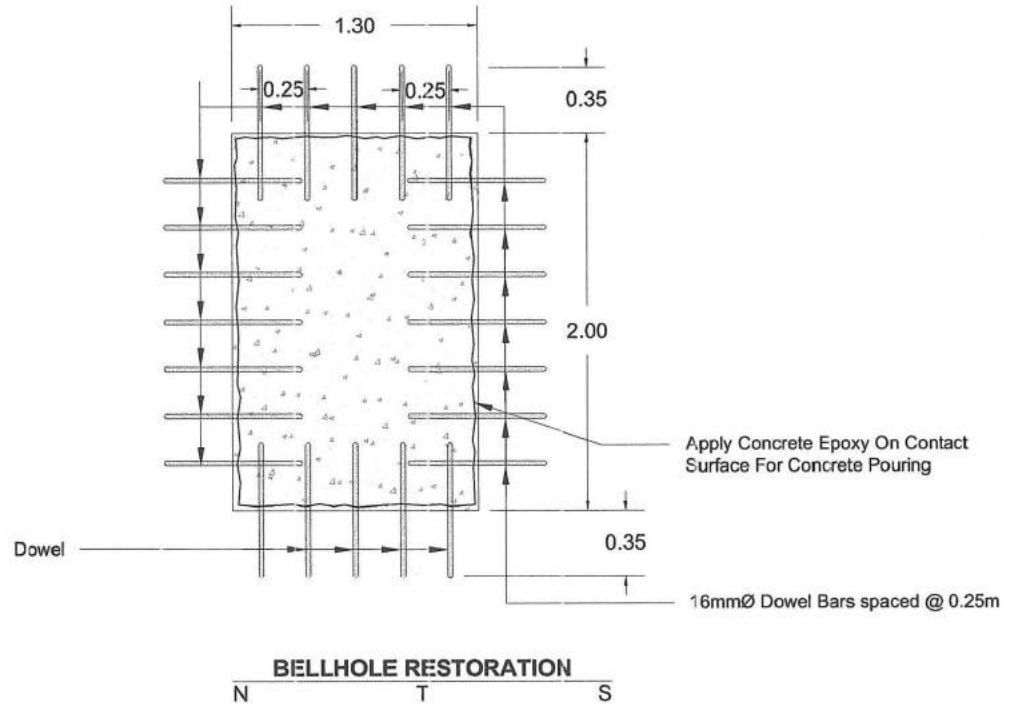
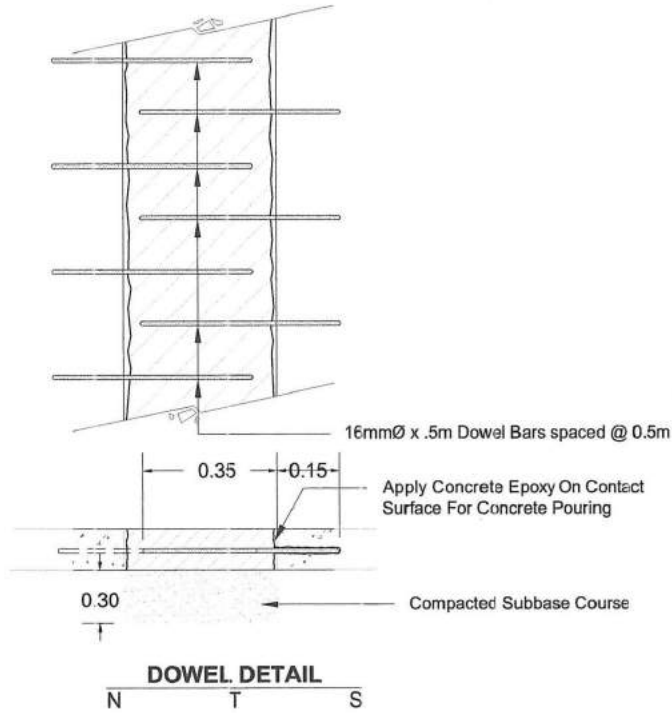

 <p>Republic of the Philippines METROPOLITAN NAGA WATER DISTRICT 40 J. Miranda Avenue, Naga City</p>	<p>PREPARED BY:</p>  SAMUEL A. AMORES OIC - Div. Mgr., P&SD	<p>CHECKED BY:</p>  SONJUNO O. MILLARES OIC - Dept. Mgr., EED	<p>RECOMMENDING APPROVAL:</p>  ROQUE S. FRANCISCO AGM, O & TS	<p>APPROVED:</p>  FLORENCIO T. MONGOSO, JR. General Manager A	<p>PROJECT TITLE/LOCATION:</p> <p>PROPOSED TRANSMISSION LINE PROJECT Pacol IV PS to Corner Happy Homes Highland to Deca Homes Vistanza Road, Barangay Pacol, Naga City 200mm Ø = 2,497 LM, 100mm Ø = 12 LM, 50mm Ø = 295 LM</p>	<p>SHEET CONTENTS:</p> <p>As Shown</p>	<p>SHEET NO.:</p> <p>9</p>
	<p>CADD BY: juliet Date Activated: 03 - 2024</p>						<p>9</p>